

出来形管理表

工事名： ○○処理区○○地区下水道整備工事

工種： 内径250mm塩ビ管布設工 管底高・勾配

測定位置図

測定箇所	管底高 A			管底高 B			管底高 C			勾配		
	設計値	測定値	差	設計値	測定値	差	設計値	測定値	差	設計値	測定値	差

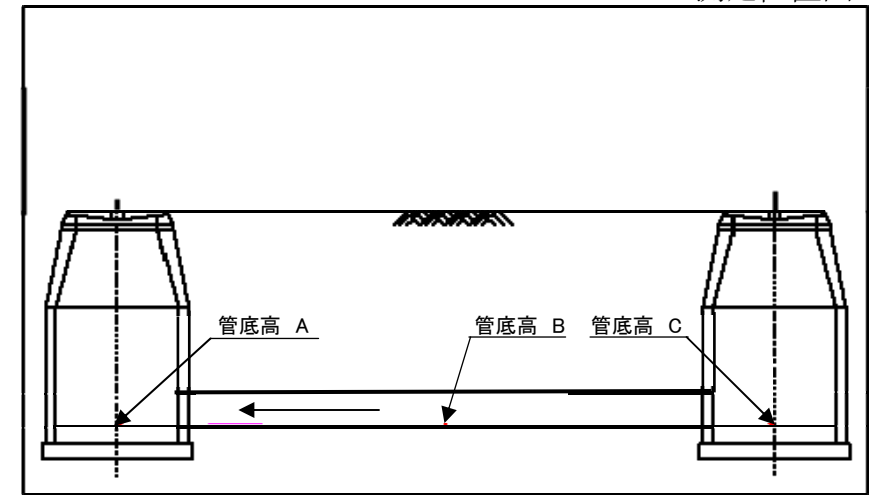

管理項目	規格値
管底高 A	±30mm
管底高 B	±30mm
管底高 C	±30mm
勾配	±10%

凡例
測定値 ————
規格値 ————

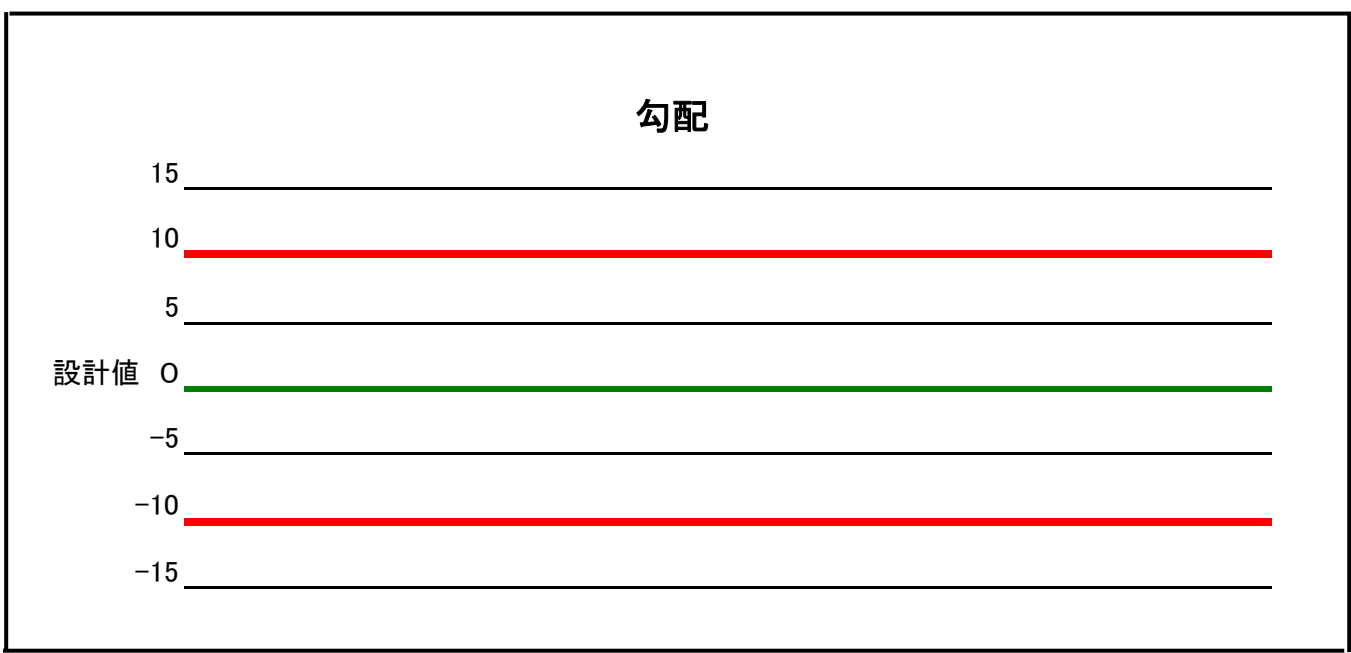

出 来 形 管 理 表

工 事 名： ○○処理区○○地区下水道整備工事

工 種： 内径250mm塩ビ管布設工 管基礎工

測定位置図

測定箇所	基準高		規格値 ±30mm	幅 B		規格値 -50mm	厚さ h		規格値 -30mm				
	設計値	測定値		差	設計値		測定値	差		設計値	測定値	差	

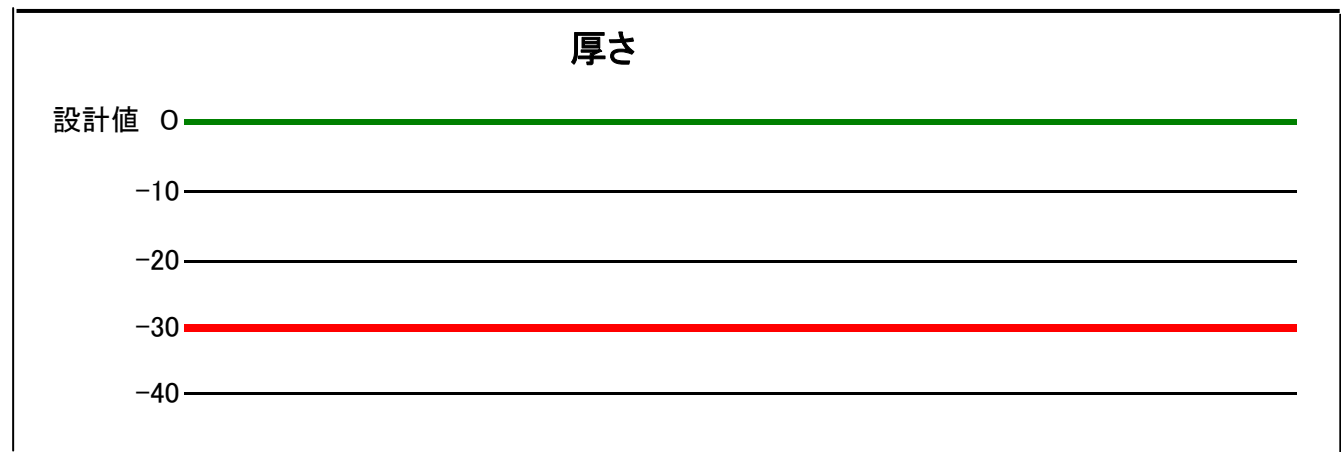
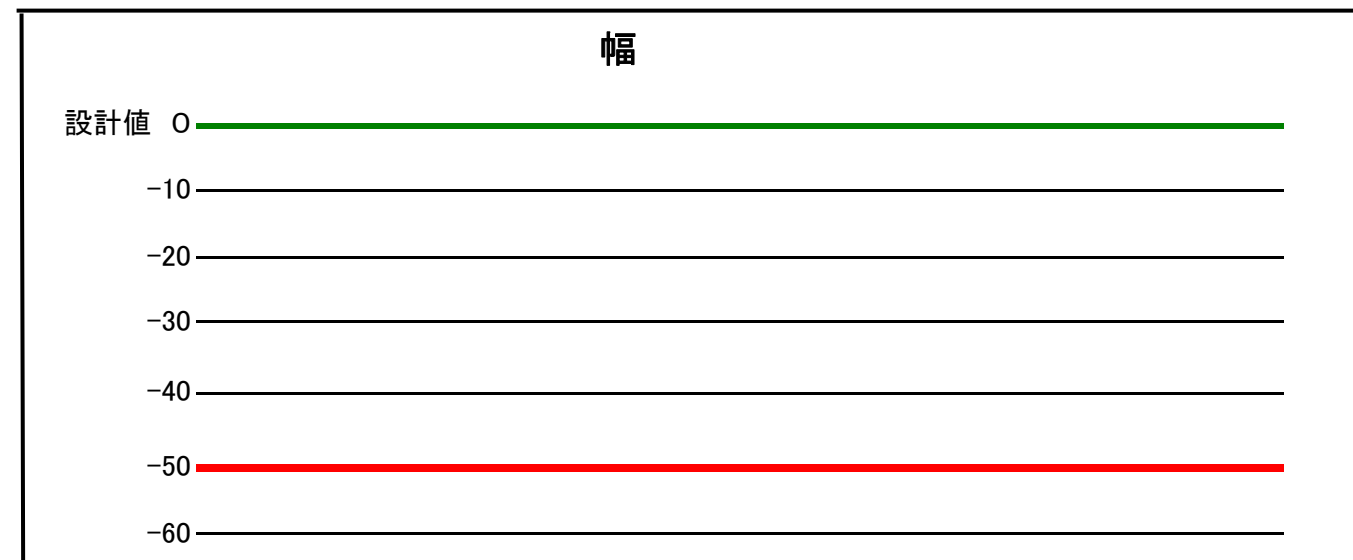
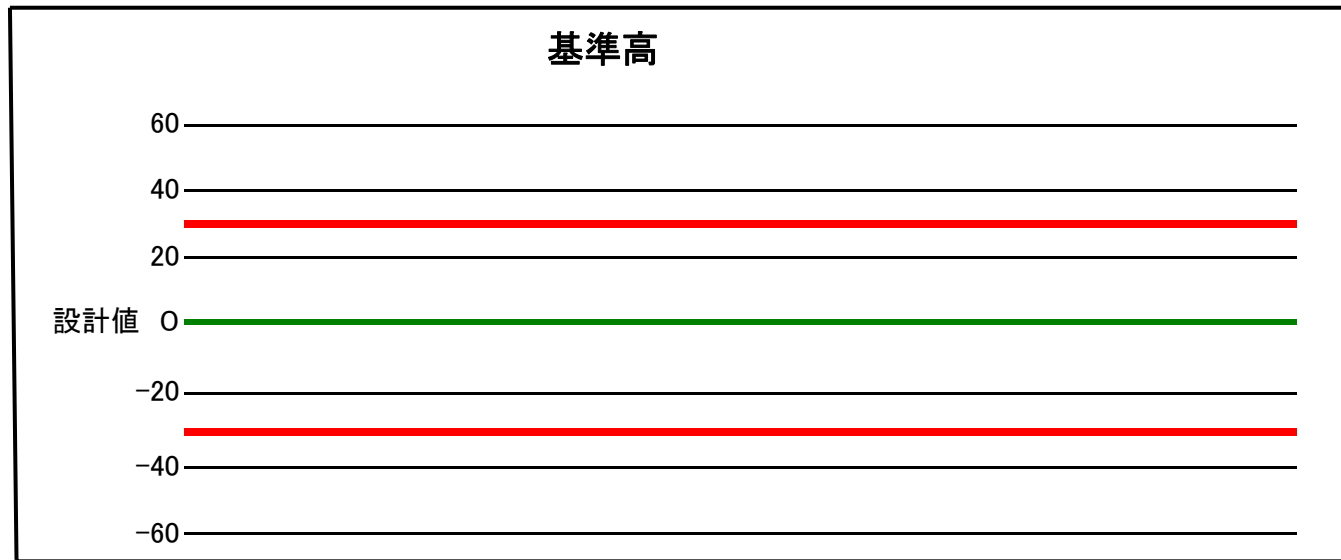
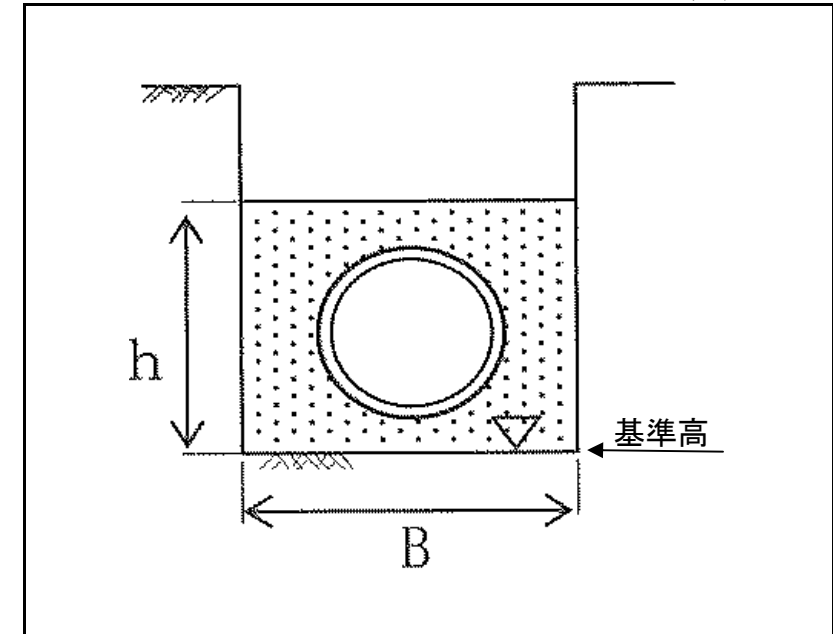

管理項目	規格値
基準高	±30mm
幅 B	-50mm
厚さ h	-30mm

凡 例

測定値 —————

規格値 ————

出 来 形 管 理 表

工 事 名： ○○処理区○○地区下水道整備工事

工 種： 内径250mm塩ビ管布設工

組立マンホール工

測定位置図

測定箇所	基準高			天端高							
	設計値	測定値	差	設計値	測定値	差					

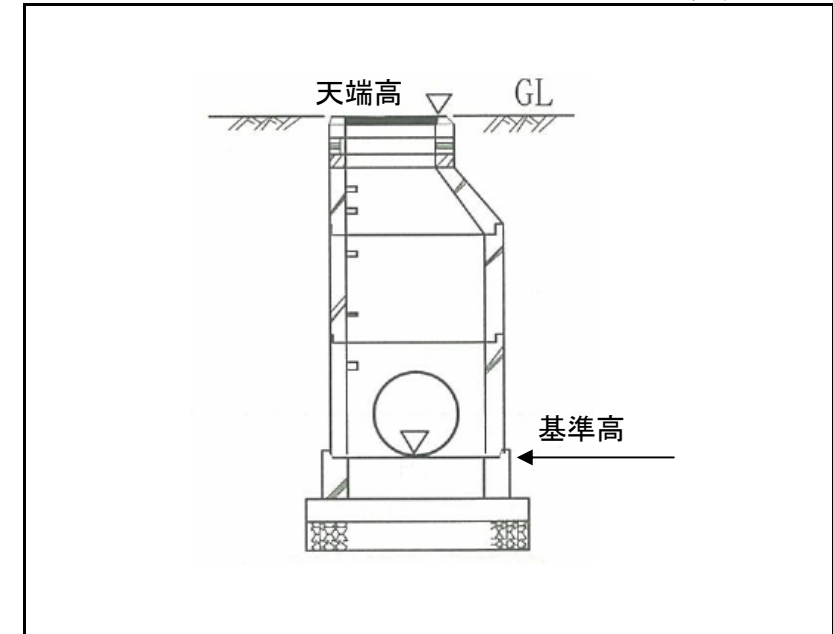

管理項目	規格値
基準高	±30mm
天端高	±30mm

凡 例
 測定値 ————
 規格値 —————

